

WORLD MARKET®

Assembly Instructions

WHITE ENAMEL 2-LIGHT SCONCE

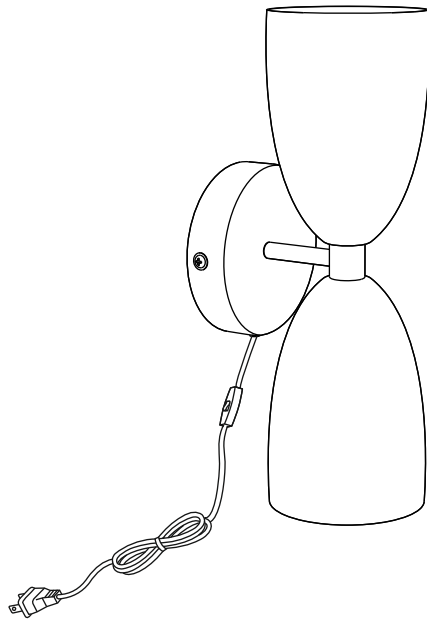

SKU-643681





Thank you for your purchase. If you have any questions pertaining to the assembly of this lighting piece, please contact the nearest World Market store. If you are not near a store, please call our customer service call center toll free at 877-967-5362 for assistance.

ALL PRODUCTS SOLD AT WORLD MARKET ARE NOT
FOR COMMERCIAL USE AND ARE INTENDED FOR
RESIDENTIAL USE ONLY.



Component List

| LABEL | PICTURE | DESCRIPTION | QTY. |
|-------|---|-------------|------|
| A |  | Lamp Body | 1 |
| B |  | Bracket | 1 |

Hardware List

| LABEL | DESCRIPTION | QTY. |
|-------|---|------|
| H-1 |  Long Screw M4 x 40 mm | 2 |
| H-2 |  Small Screw M4 x 16 mm | 2 |
| H-3 |  Wall Plug | 2 |

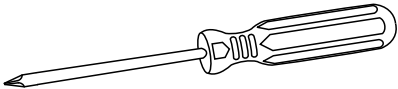
Tool List

| LABEL | PICTURE | DESCRIPTION | QTY. |
|-------|---|-------------------------------|-----------------|
| T-1 |  | Screwdriver (not included) | Not Included |
| T-2 |  | Screwdriver (not included) | Not Included |
| T-3 |  | Screwdriver (not included) | Not Included |

Assembly Preparation

Before Beginning:

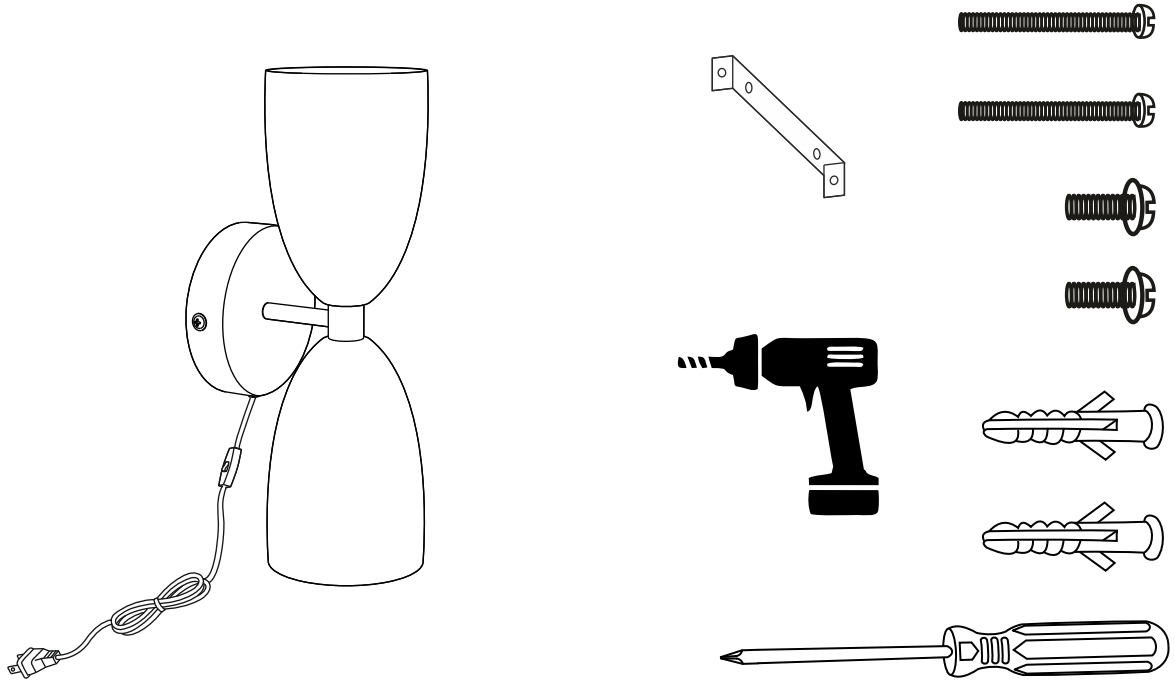

Unpack all hardware bags and components to ensure you have all parts. Take note of bolt hardware size differences and components that may have directional labels (Example: TOP or FRONT).



It is always recommended to have 2 adults on hand for assembly.



Read the assembly instructions, cover-to-cover. Save any **Care and Maintenance** instructions pages for after the assembly has been completed.



Do not assemble on hard, abrasive flooring or carpeted surfaces that can damage or get caught in the components during assembly.

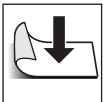

Assemble on a clean non-marring surface (such as the product's packing foam).



Do not discard any packaging until the product has been fully assembled.



In case of missing parts, please contact your nearest World Market store or call our customer service call center at 1-877-967-5362.



WARNING: Small parts are a choking hazard. Adult supervision is required before, during, and after assembly.

Assembly Steps

! WARNING - ELECTRICAL FIXTURE. PROFESSIONAL INSTALLATION RECOMMENDED.

FOR YOUR SAFETY: Shut off the power to the main electric circuit supply before beginning any work. Lock out the circuit or the circuit breaker panel so the power can not be turned on while you are working. If handled improperly, electricity poses risk of personal injury or fire hazards. Professional installation is recommended.

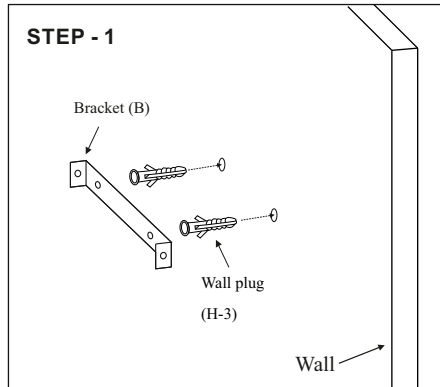

Step-1

1. Place Bracket (B) on the wall at your desired location. Ensure the power cord will reach an outlet. It is suggested to use a Level (T-2; not included) to ensure the product is level. Mark the locations of the through holes onto the wall. Pre-drill holes on marked location using a Power Drill (T-3; not included) and a drill bit roughly the same diameter of the Wall Plugs (H-3).
2. Insert the Wall Plugs (H-3) into the pre-Drilled holes until they are roughly flush with the surface of the wall.

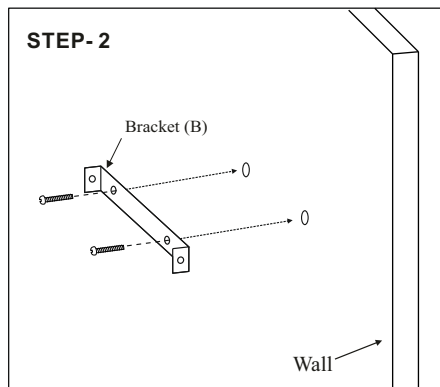

Step-2

1. Align holes of Bracket (B) with the Wall Plug (H-3) and secure with Long Screw (H-1) using a Screwdriver (T-1; not included). Fully tighten, but DO NOT OVER TIGHTEN.

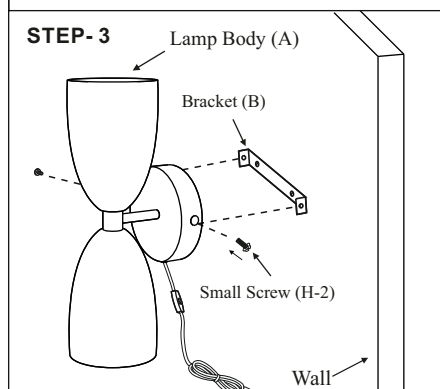

Step-3

1. Place the Lamp Body (A) over Bracket (B) so that the side holes align with one another as shown. Insert Small Screw (H-2) into the side holes and tighten with a Screwdriver (T-1, not included).
2. Check your work and that all connections have been fully tightened.

Bulb Installation

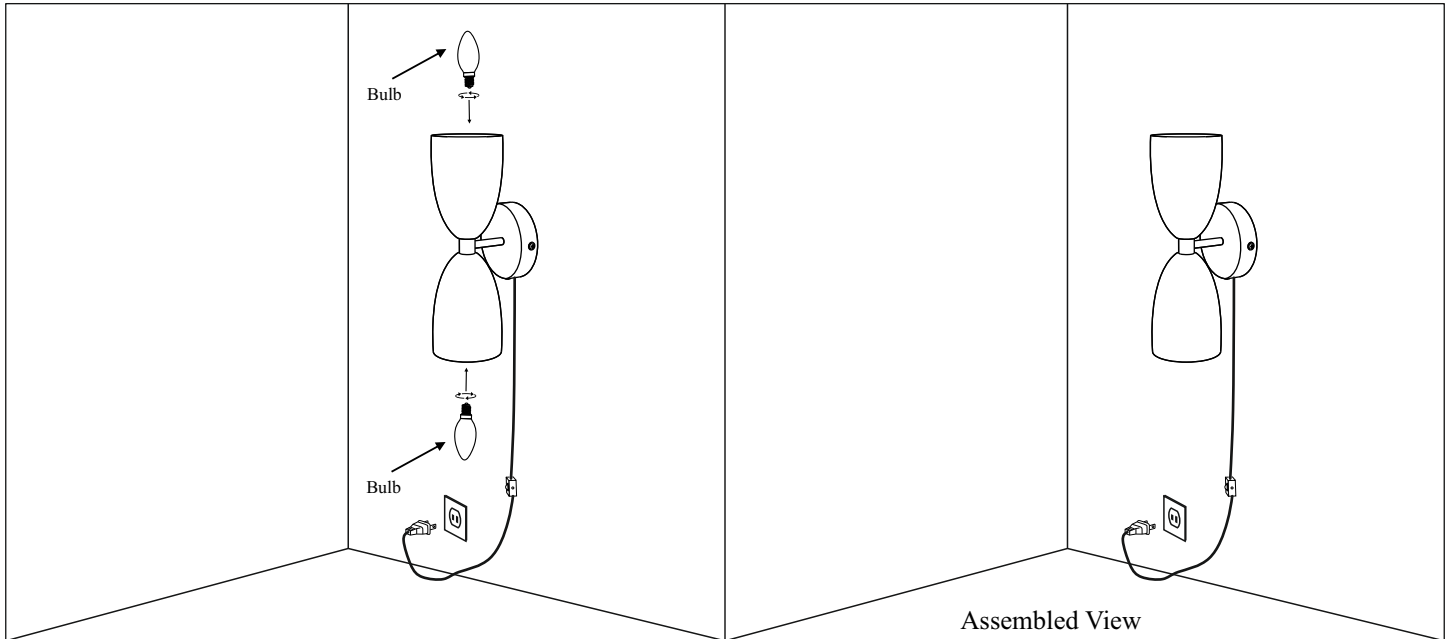

Insert Bulbs (not included) into the socket and rotate it in clockwise to secure. Restore power to the circuit at this time and check for proper lighting operation. Assembly is now complete and the product is ready for use.

Warnings



All products sold at World Market are not for commercial use and are intended for residential use only.



To prevent the risk of fire, DO NOT use light bulbs with wattage greater than 2 x 25 Watt and 5 watt LED. Use Type B Bulb for this product. Bulbs sold separately.



Never turn on power to the lamp until light bulb has been installed and assembly is completed.

Care & Maintenance



DO NOT clean furniture with harsh cleansers or polish.



DO NOT place fixture outside. For INDOOR USE ONLY.



Fixture can be dusted using a clean, non-colored, lint-free dry cloth.

"NOTE: This product is a handcrafted item and natural/subtle variations may be present in the finish or craftsmanship. These aesthetic variations do not impact the use of the product."

WORLD MARKET®

Assembly Instructions

WHITE ENAMEL 1-LIGHT SCONCE

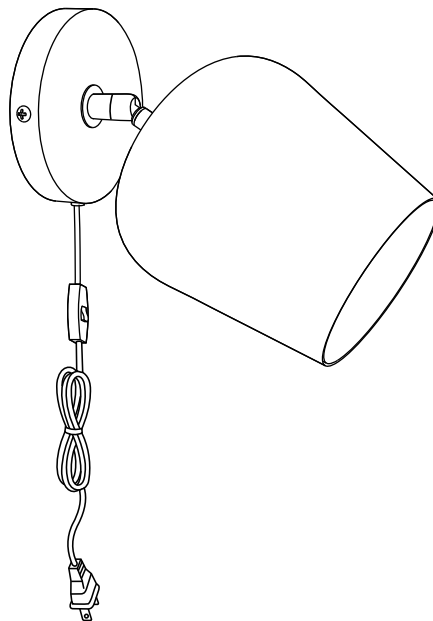

SKU-643692





Thank you for your purchase. If you have any questions pertaining to the assembly of this lighting piece, please contact the nearest World Market store. If you are not near a store, please call our customer service call center toll free at 877-967-5362 for assistance.

ALL PRODUCTS SOLD AT WORLD MARKET ARE NOT
FOR COMMERCIAL USE AND ARE INTENDED FOR
RESIDENTIAL USE ONLY.



Component List

| LABEL | PICTURE | DESCRIPTION | QTY. |
|-------|---|-------------|------|
| A |  | Lamp Body | 1 |
| B |  | Bracket | 1 |

Hardware List

| LABEL | DESCRIPTION | QTY. |
|-------|---|------|
| H-1 |  Long Screw M4 x 40 mm | 2 |
| H-2 |  Small Screw M4 x 16 mm | 2 |
| H-3 |  Wall Plug | 2 |

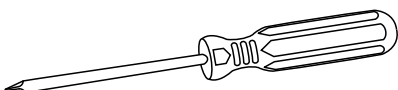
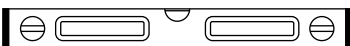
Tool List

| LABEL | PICTURE | DESCRIPTION | QTY. |
|-------|---|-------------------------------|-----------------|
| T-1 |  | Screwdriver (not included) | Not Included |
| T-2 |  | Screwdriver (not included) | Not Included |
| T-3 |  | Screwdriver (not included) | Not Included |

Assembly Preparation

Before Beginning:

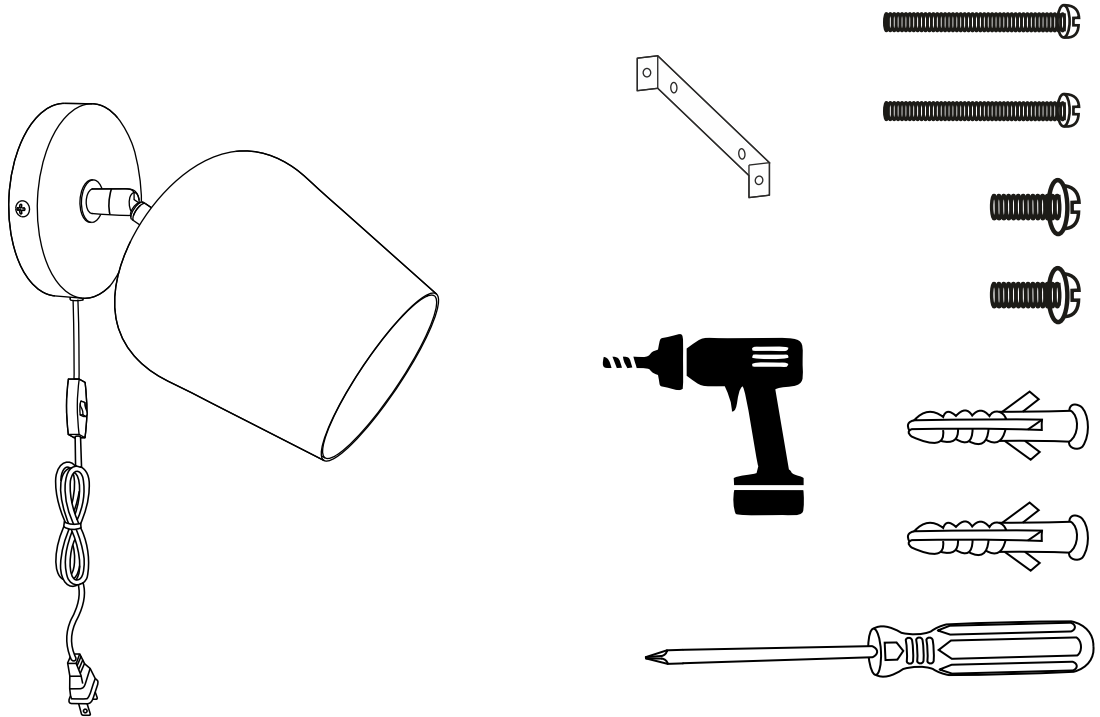

Unpack all hardware bags and components to ensure you have all parts. Take note of bolt hardware size differences and components that may have directional labels (Example: TOP or FRONT).



Read the assembly instruction, cover-to-cover. Save any **Care and Maintenance** instructions pages for after the assembly has been completed.



It is always recommended to have 2 adults on hand for assembly.



Do not assemble on hard, abrasive flooring or carpeted surfaces that can damage or get caught in the components during assembly.

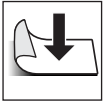

Assemble on a clean non-marring surface (such as the product's packing foam).

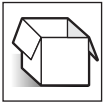

Do not discard any packaging until the product has been fully assembled.



In case of missing parts, please contact your nearest World Market store or call our customer service call center at 1-877-967-5362.



WARNING: Small parts are a choking hazard. Adult supervision is required before, during, and after assembly.

Assembly Steps

! WARNING - ELECTRICAL FIXTURE. PROFESSIONAL INSTALLATION RECOMMENDED.

FOR YOUR SAFETY: Shut off the power to the main electric circuit supply before beginning any work. Lock out the circuit or the circuit breaker panel so the power can not be turned on while you are working. If handled improperly, electricity poses risk of personal injury or fire hazards. Professional installation is recommended.

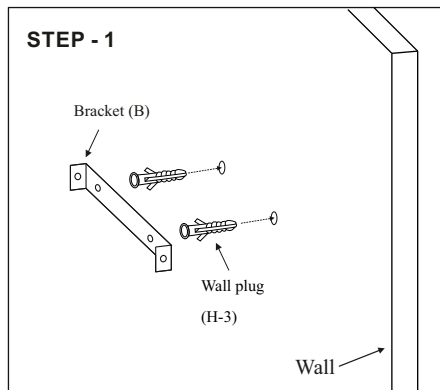

Step-1

1. Place Bracket (B) on the wall at your desired location. Ensure the power cord will reach an outlet. It is suggested to use a Level (T-2; not included) to ensure the product is level. Mark the locations of the through holes onto the wall. Pre-drill holes on marked location using a Power Drill (T-3; not included) and a drill bit roughly the same diameter of the Wall Plugs (H-3).
2. Insert the Wall Plugs (H-3) into the pre-Drilled holes until they are roughly flush with the surface of the wall.

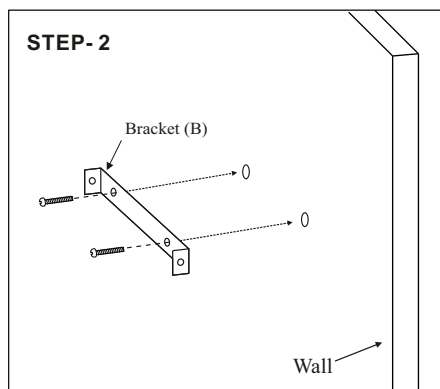

Step-2

1. Align holes of Bracket (B) with the Wall Plug (H-3) and secure with Long Screw (H-1) using a Screwdriver (T-1; not included). Fully tighten, but DO NOT OVER TIGHTEN.

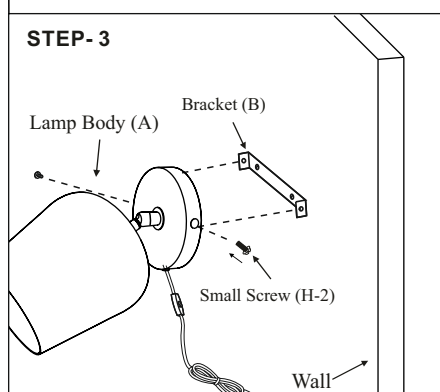

Step-3

1. Place the Lamp Body (A) over Bracket (B) so that the side holes align with one another as shown. Insert Small Screw (H-2) into the side holes and tighten with a Screwdriver (T-1, not included).
2. Check your work and that all connections have been fully tightened.

Bulb Installation

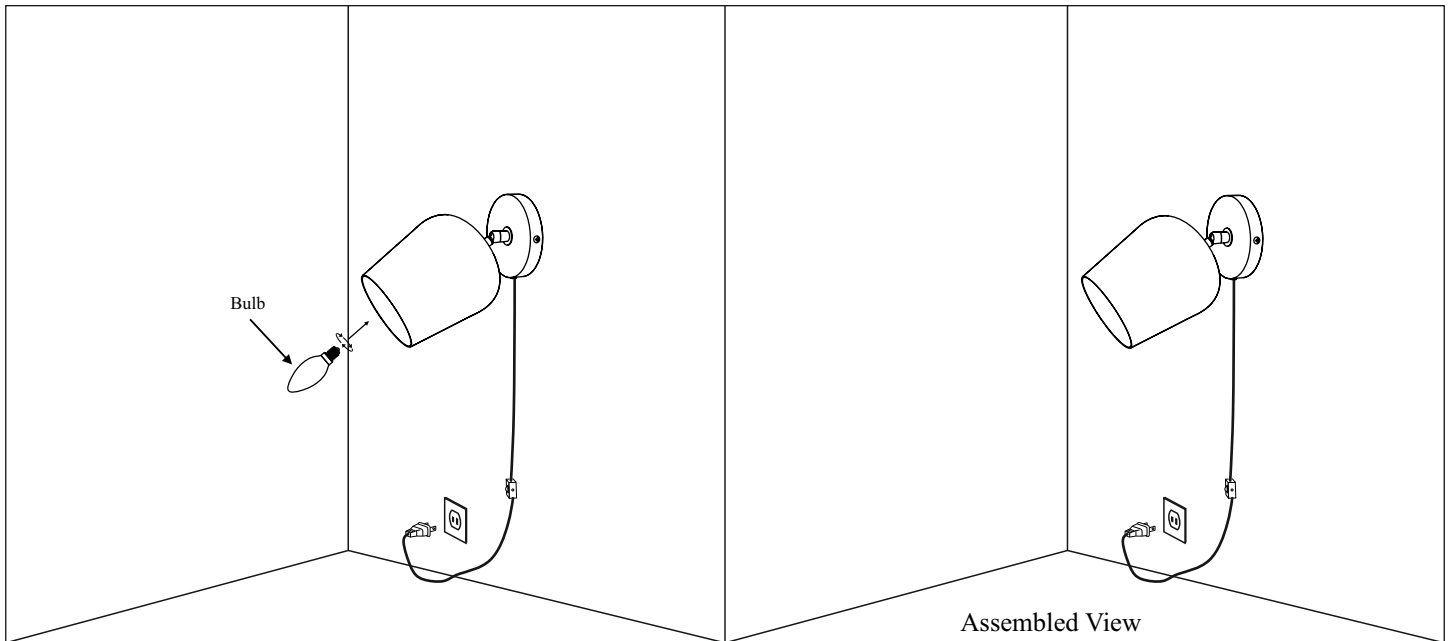

Insert Bulbs (not included) into the socket and rotate it in clockwise to secure. Restore power to the circuit at this time and check for proper lighting operation. Assembly is now complete and the product is ready for use.

Warnings



All products sold at World Market are not for commercial use and are intended for residential use only.



To prevent the risk of fire, **DO NOT** use light bulbs with wattage greater than 25 Watt and 5 watt LED. Use Type B Bulb for this product. Bulbs sold separately.



Never turn on power to the lamp until light bulb has been installed and assembly is completed.

Care & Maintenance



DO NOT clean furniture with harsh cleansers or polish.



DO NOT place fixture outside. For **INDOOR USE ONLY**.



Fixture can be dusted using a clean, non-colored, lint-free dry cloth.

"NOTE: This product is a handcrafted item and natural/subtle variations may be present in the finish or craftsmanship. These aesthetic variations do not impact the use of the product."