

Please read below before assembly

- Assemble the product on a flat, soft surface such as a carpet or cloth to prevent scratching the finish.
- Do not discard any content until assembly is complete to avoid accidentally discarding small parts or hardware.
- Take out all parts and hardware from box.
- Failure to follow these instructions may cause the bolts to misalign during assembly.

DISCLAIMERS:

- WHEN PROPERLY ASSEMBLED, THIS ITEM IS SAFE FOR INTENDED USE. SELLER IS NOT LIABLE FOR ANY DAMAGES RESULTING FROM ITEM BEING IMPROPERLY ASSEMBLED AFTER PURCHASE.
- BOLTS MAY LOOSEN DURING NORMAL EVERYDAY USE. THEY SHOULD BE INSPECTED AT LEAST EVERY 3 MONTHS AND RE-TIGHTENED AS NEEDED TO PREVENT DAMAGE OR INJURY, AND ENSURE STABILITY.

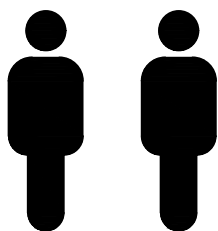

PEOPLE NEEDED





300
lbs seat

WEIGHT LIMIT





ESTIMATED TIME

PARTS LIST

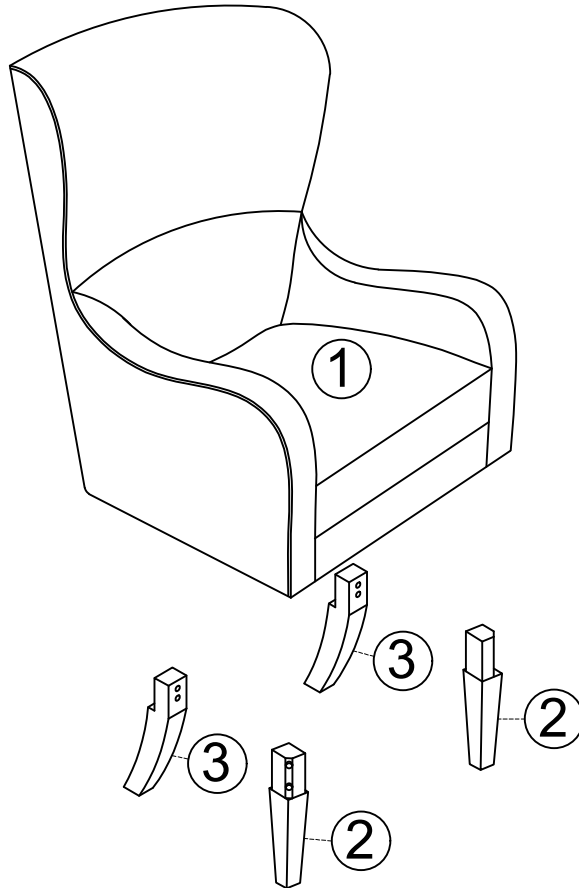
| | | | |
|---|------------|---|-------|
| ① | CHAIR BODY |  | 1 PC |
| ② | FRONT LEG |  | 2 PCS |
| ③ | BACK LEG |  | 2 PCS |

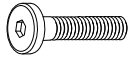

HARDWARE LIST

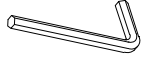

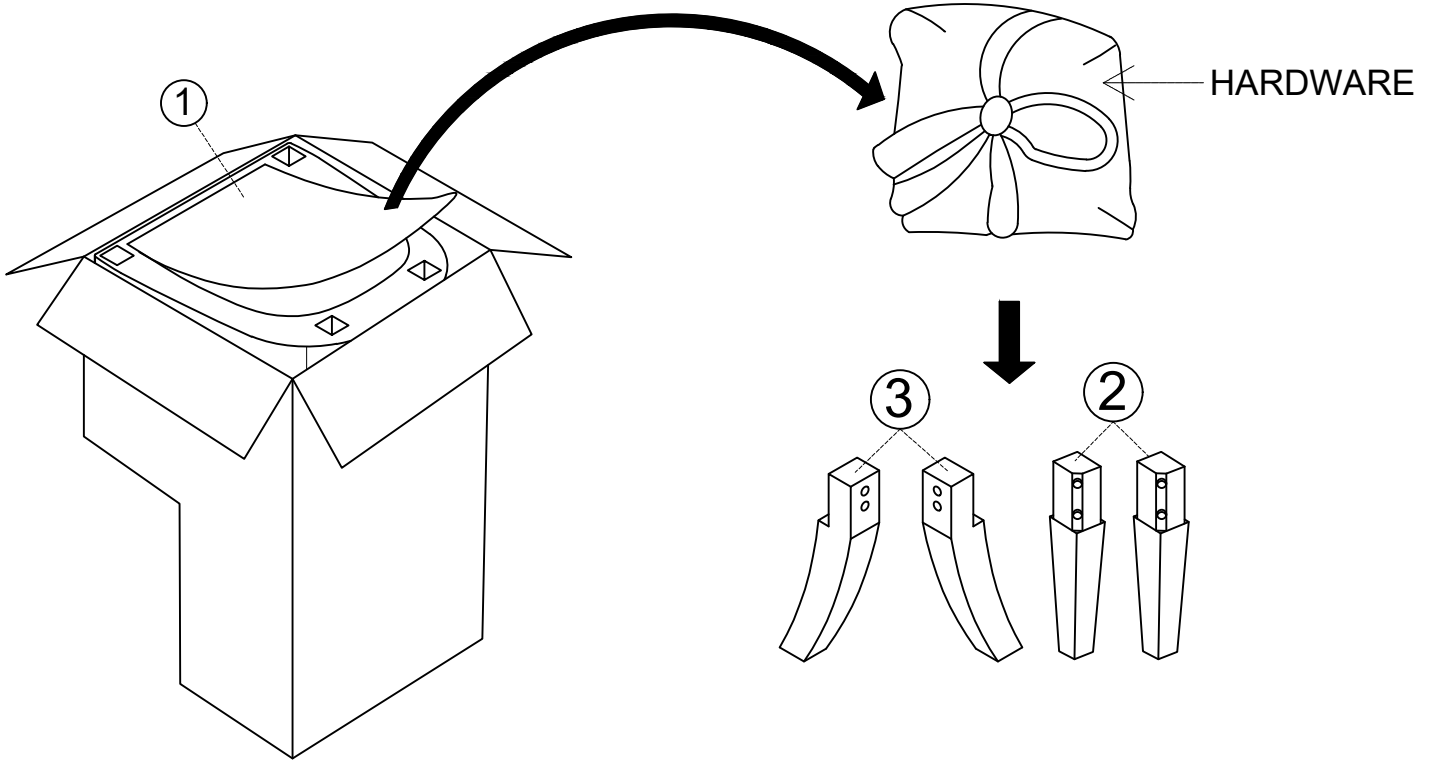

| | | | |
|---|----------------------|---|-------|
| A | BOLT- Ø5/16" x 2" |  | 8 PCS |
| B | LOCK WASHER - Ø5/16" |  | 8 PCS |
| C | FLAT WASHER - Ø5/16" |  | 8 PCS |
| D | ALLEN KEY - 5/16" |  | 1 PC |

STEP 1

LOCATE PARTS AND HARDWARE
FROM CHAIR BOTTOM

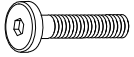



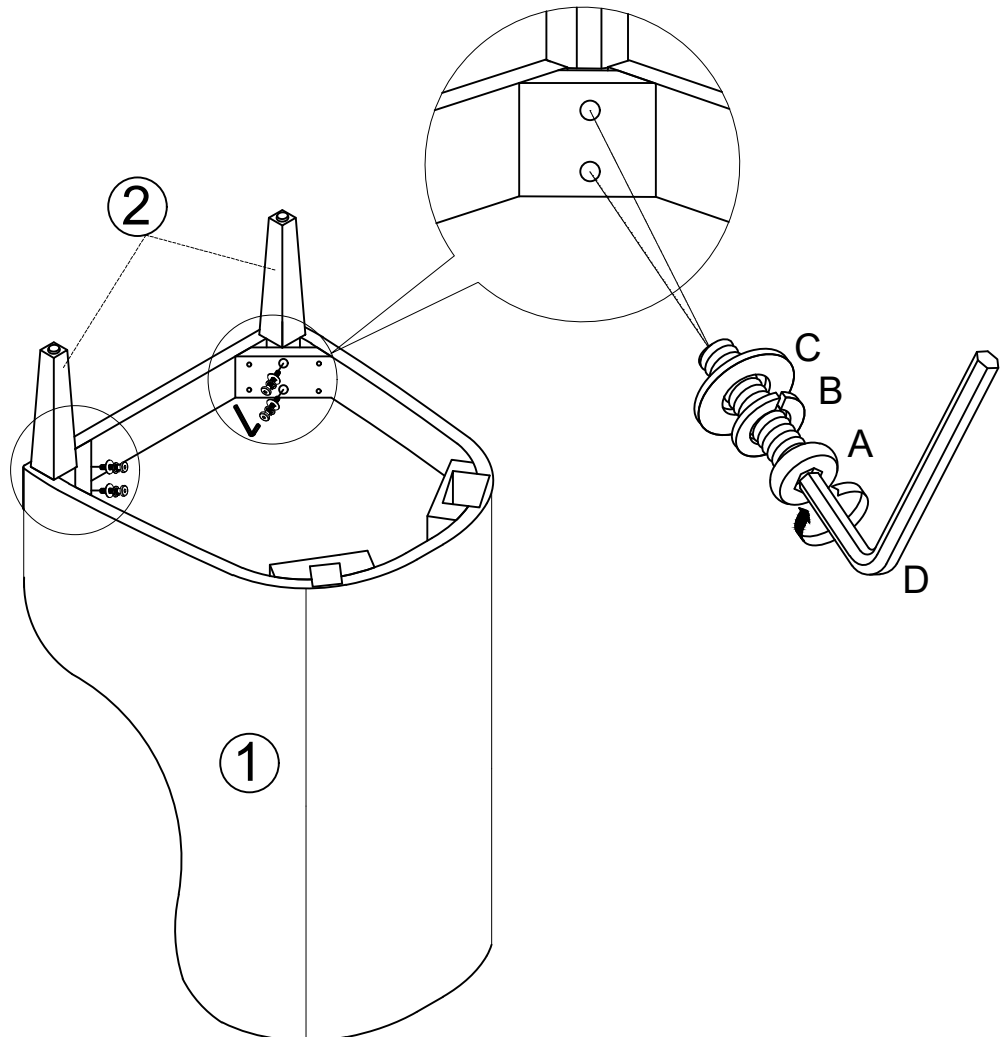

STEP 2

| | | |
|---|---|-------|
| A |  | 4 PCS |
| B |  | 4 PCS |
| C |  | 4 PCS |
| D |  | 1 PC |

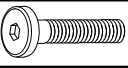

STEP 3

| | | |
|---|---|-------|
| A |  | 4 PCS |
| B |  | 4 PCS |
| C |  | 4 PCS |
| D |  | 1 PC |

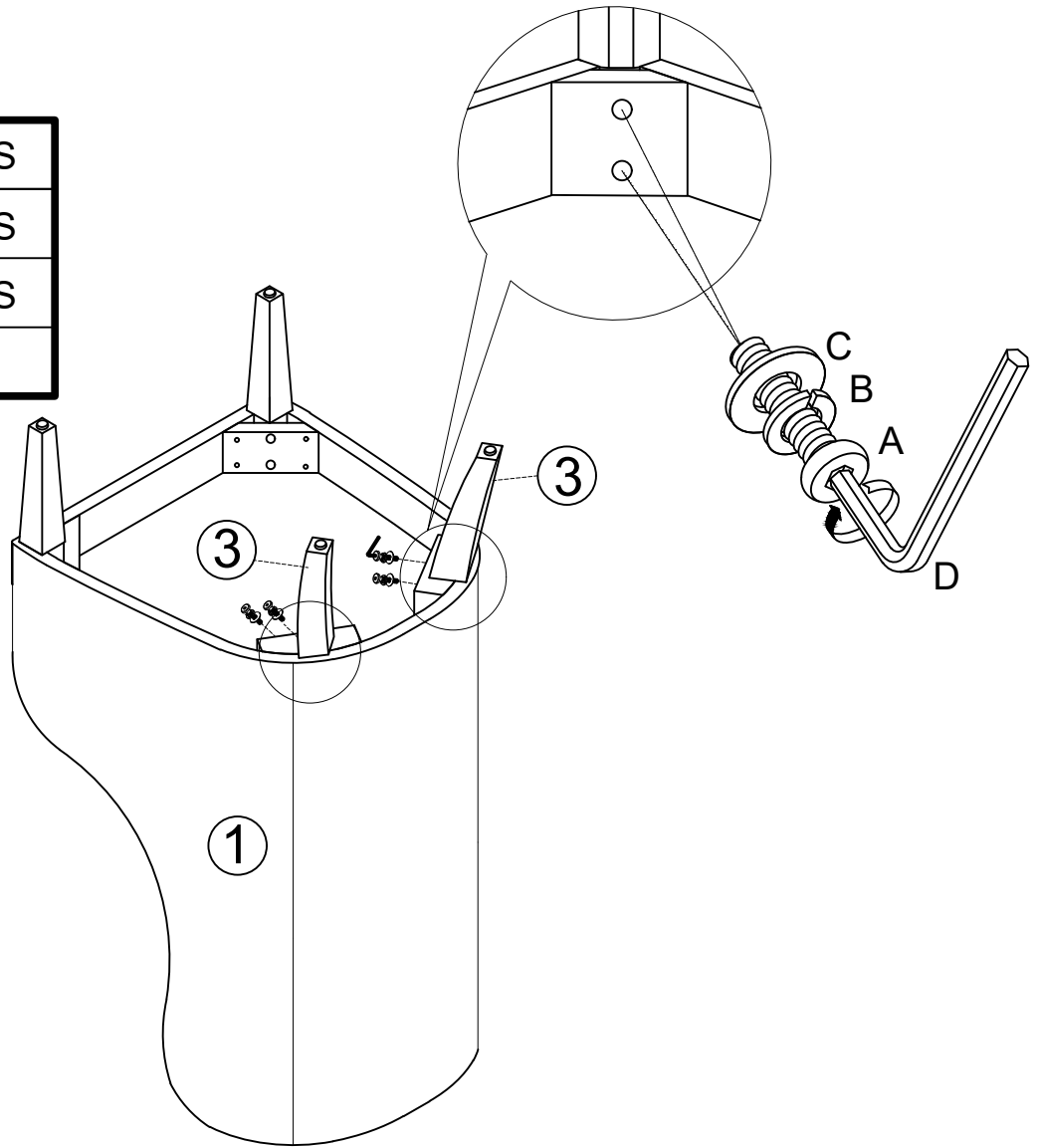

STEP 4

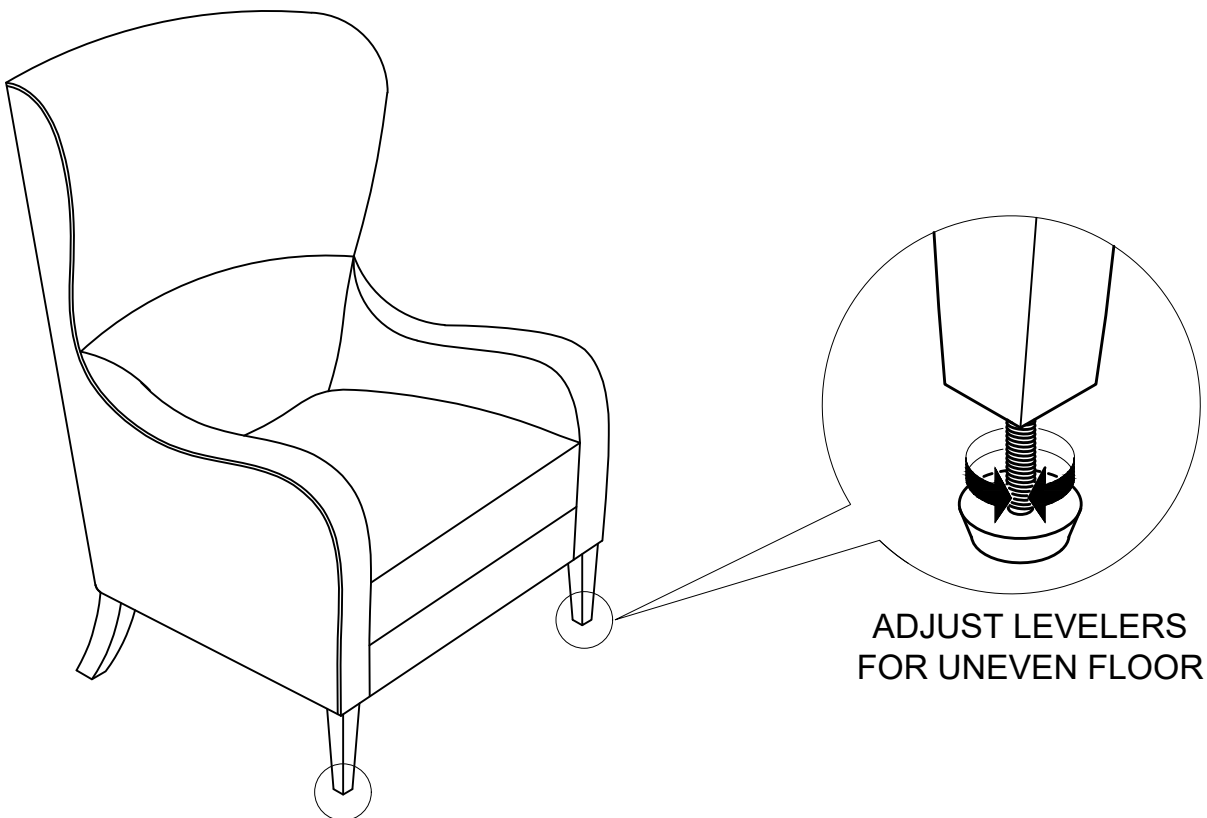

Care & Maintenance

Do...



Wipe up spills immediately.



Dust and pick-up spills using a clean, non-colored, lint-free, dry cloth.



Use mild non-abrasive soap and water.

Don't...



Do not put hot items directly on furniture surface.



Do not clean furniture with harsh cleansers or polish.

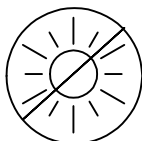

Do not place furniture in direct sunlight.



Do not place furniture near heating or cooling vents.

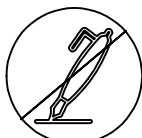

Do not write on furniture without a padded barrier to protect the surface.



Do not place furniture outside. For indoor use only.