

# WORLD MARKET®

## Assembly Instructions

### Adirondack Rocking Chair

SKU



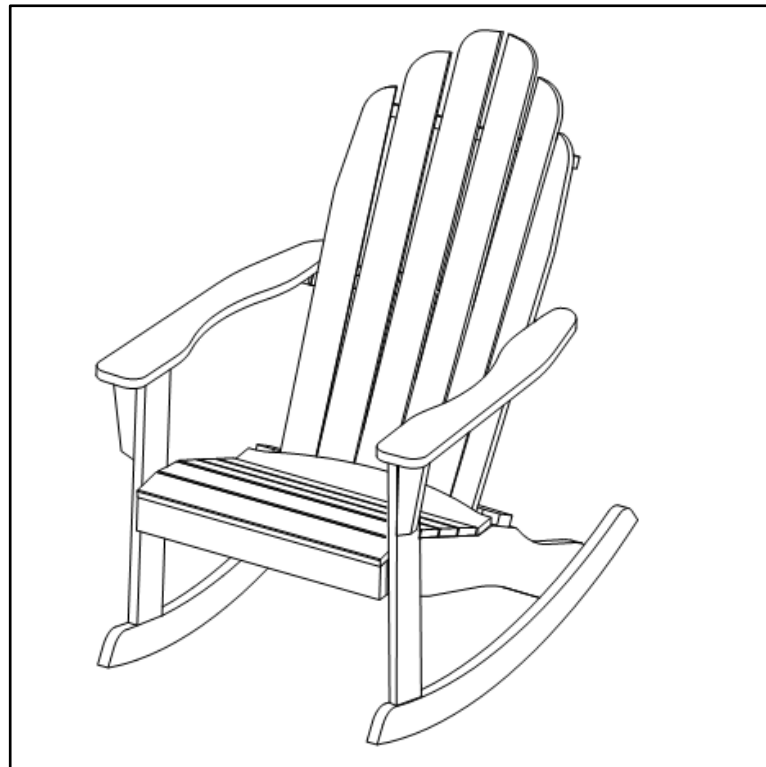

567677, 569644, 569643





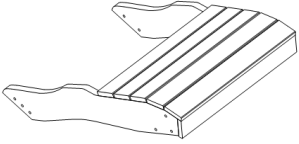

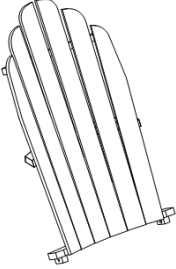
THANK YOU FOR YOUR PURCHASE. IF YOU HAVE ANY QUESTIONS  
PERTAINING TO THE ASSEMBLY OF THIS FURNITURE PIECE, PLEASE CONTACT  
THE NEAREST COST PLUS WORLD MARKET STORE.  
IF YOU ARE NOT NEAR A STORE, PLEASE CALL OUR CUSTOMER SERVICE CALL  
CENTER TOLL FREE AT 877-967-5362 FOR ASSISTANCE.

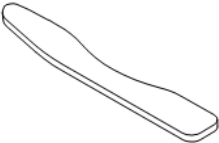
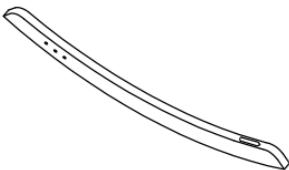
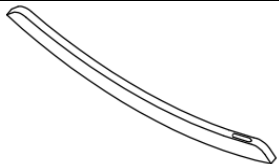
**NOT FOR COMMERCIAL USE**

# Component List

LABEL	PICTURE	DESCRIPTION	QTY
A		Seat Slat	1
B		Seat	1
C		Left Leg	1
D		Right Leg	1
E		Backrest	1
F		Left Armrest	1
K		Right Armrest	1
H		Left Rocker	1
G		Right Rocker	1

## Hardware List

LABEL	PICTURE	DESCRIPTION	QTY
H-1		Allen Bolt M6 x 35mm	18
H-2		Spring Washer 1 x 7/10mm	6
H-3		Flat Washer 1 x 6.5/14mm	6
H-4		Wood Dowel 8 x 20mm	6
H-5		Screw 6 x 90mm	2

## Tool List

LABEL	PICTURE	DESCRIPTION	QTY
T-1		Allen Key	1

# Assembly Preparation

## Before Beginning:

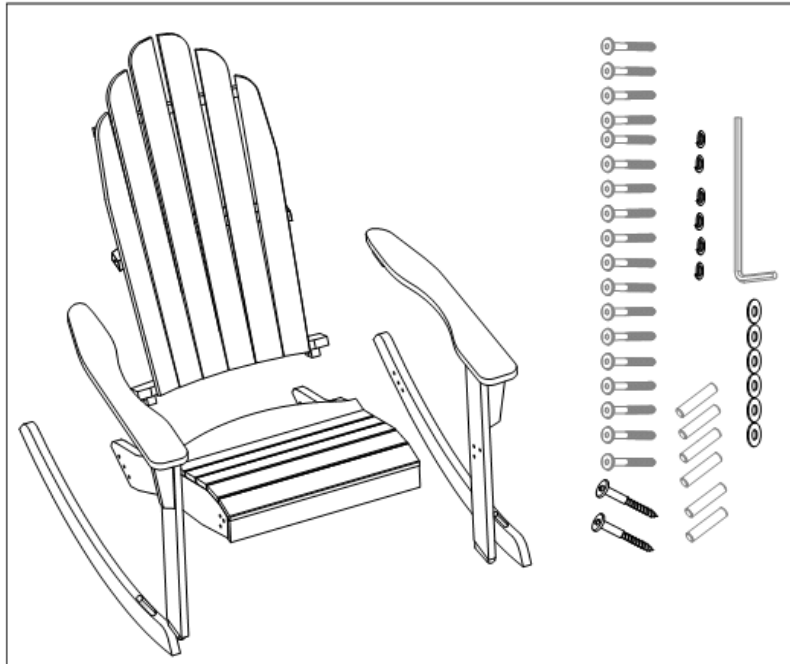

- **Unpack all hardware bags and components to ensure you have all parts-**



- **Read instructions, cover to cover-**



- **Have 2 adults on hand for assembly-**



- **Do not assemble on flooring or carpet-**



- **Assemble on a clean non-marring surface (packing foam)-**



- **Save all packaging until finished-**





- **In case of missing parts, please contact your nearest Cost Plus World Market store or call our customer service call center at call 1-877-967-5362.**

# Assembly Steps

**Note: Do not fully tighten any bolts until the last step.**

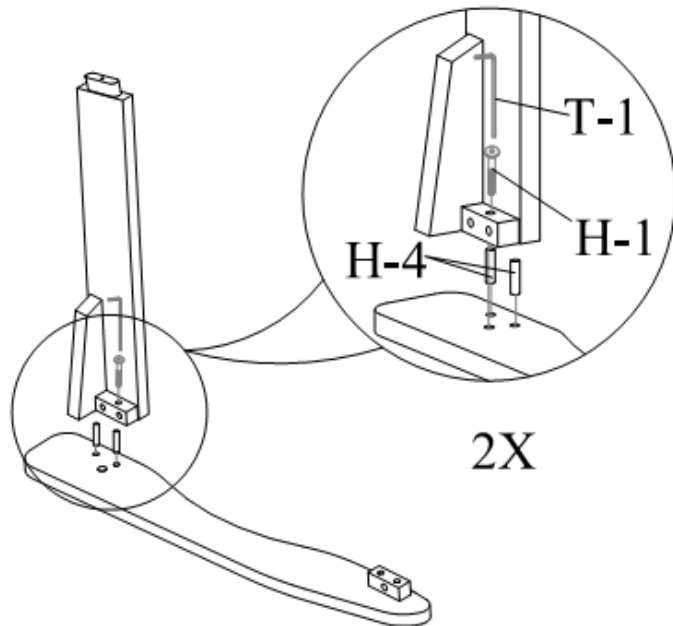

## Step 1

-  (H-1) Allen Bolt x2
-  (H-4) Wood Dowel x4
-  (T-1) Allen Key



- Place Right Armrest (K) onto a non-marring surface with the pre-drill holes facing up. Insert 2 Wood Dowels (H-4) into the parallel pre-drilled holes as shown.
- Attach Right Leg (D) to Right Armrest (K) using the 2 Wood Dowels (H-4) and Allen Bolt (H-1) through the center hole on block.
- Engage the bolt using Allen Key (T-1) but do not fully tighten it.
- Repeat the process for the Left Armrest (F) and Left Leg (C) assembly.

## Step 2



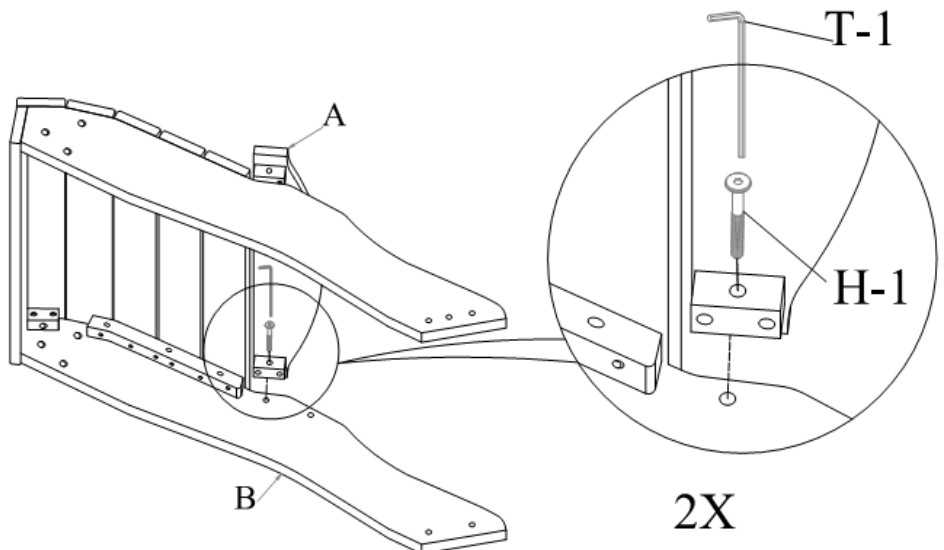

-  (H-1) Allen Bolt x2
-  (T-1) Allen Key



- Place Seat (B) down onto a non-marring surface and on its side as shown.
- Attach each end of Seat Slat (A) to Seat (B) using Allen Bolts (H-1) and Allen Key (T-1). Engage the bolts but do not fully tighten them.

# Assembly Steps

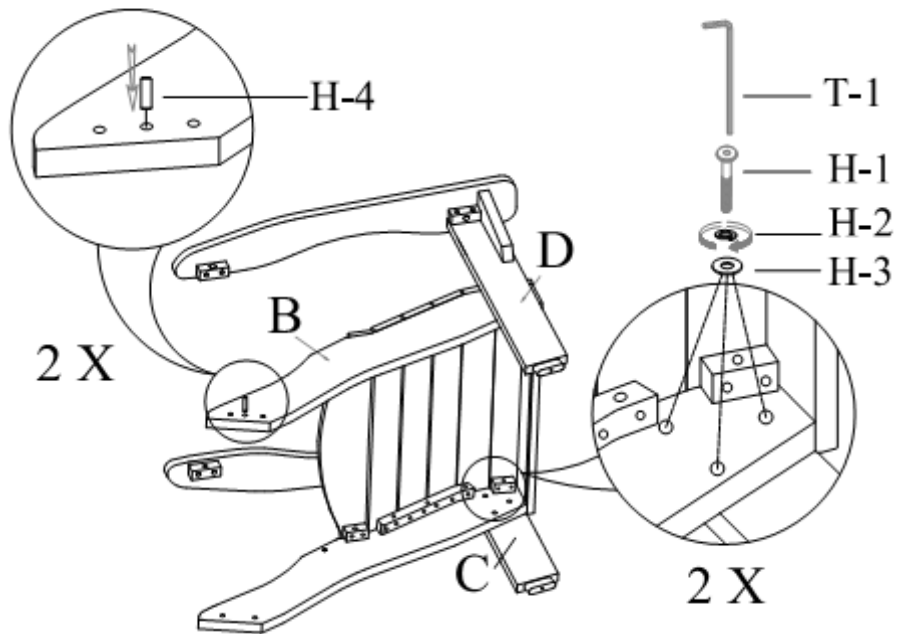

## Step 3

-  (H-1) Allen Bolt x6
-  (H-2) Spring Washer x6
-  (H-3) Flat Washer x6
-  (H-4) Wood dowel x2
-  (T-1) Allen Key

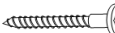

- Attach the Right Leg (D) to the seat assembly using Allen Bolt (H-1), Spring Washers (H-2) and Flat Washers (H-3). Do not fully tighten bolts until all parts are installed.
- Repeat for the Left Leg (C).
- Place the Wood Dowels (H-4) in the middle hole of the back legs of the seat (B).

## Step 4

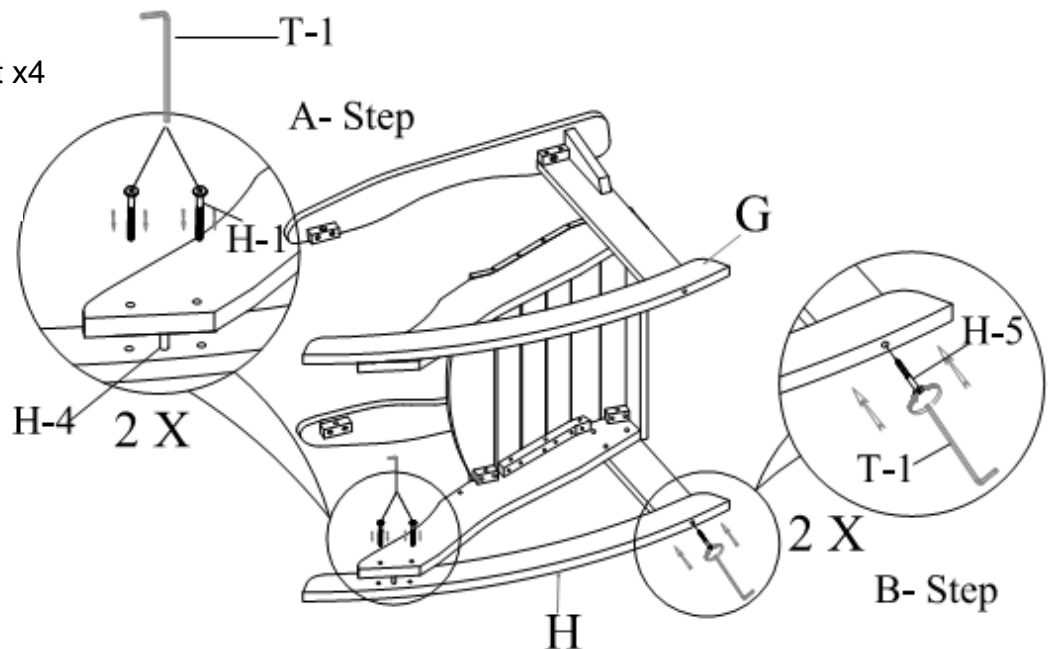

-  (H-1) Allen Bolt x4
-  (H-5) Screw x2
-  (T-1) Allen Key



- Insert tenon on Right Leg (D) into corresponding slot on Right Rocker (G) and installed dowel into corresponding middle hole at back of rocker.
- Secure Right Rocker (G) to the seat assembly using Allen Bolts (H-1). Do not fully tighten bolts.
- Secure Right Rocker (G) to the Right Leg (D) using Screw (H-5). Fully tighten screw and bolts using Allen Key (T-1).
- Repeat for the Left Rocker (H).

# Assembly Steps

## Step 5

-  (H-1) Allen Bolt x4
-  (T-1) Allen Key

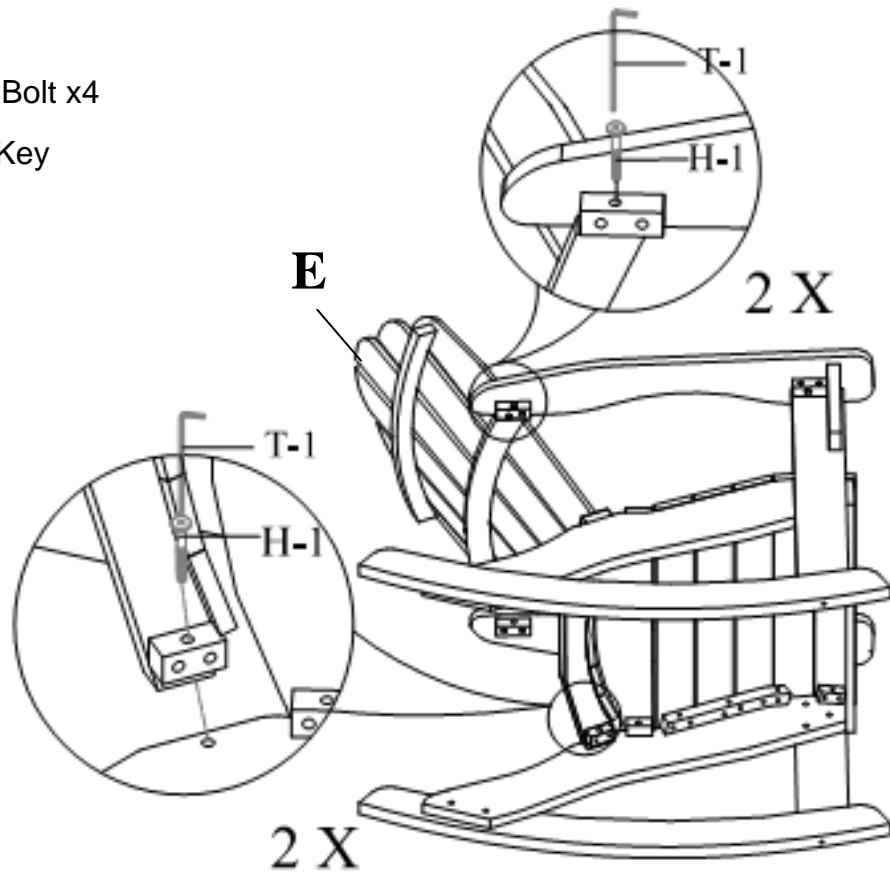

- Attach Backrest (E) to each end of the Seat (B) assembly and both Armrests (C/D).
- Secure using Allen Bolts (H-1) and Allen Key (T-1). Engage the bolts but do not fully tighten them.

## Step 6

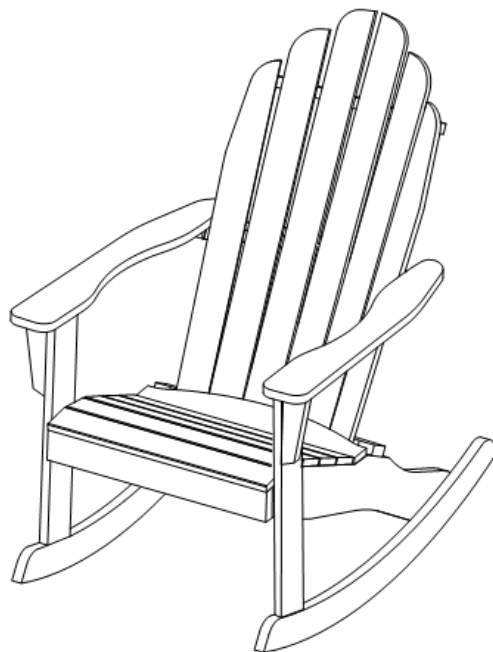

Fully tighten ALL Allen bolts from Steps 1-5 at this time using Allen Key (T-1). Do not over-tighten bolts. Carefully turn the assembly upright and the chair is now ready for use.

# Care & Maintenance



- Do not put hot items directly on furniture surface.



- Do not clean furniture with harsh cleansers or polish.



- Do not place furniture near heating or cooling vents.



- Do not write on furniture without a padded barrier to protect the surface



- Store furniture or use an appropriate furniture cover during cold or inclement weather.



- Not for commercial use. For residential use only.



- Dust and pick-up spills using a clean, non-colored, lint-free cloth. Stains may be removed with a damp cloth.
- 

## CAUTION

As with any wood, the color may fade if left in direct sunlight or inclement weather. For Natural wood finishes, we recommend using our Outdoor Wood Finish to help preserve the finish.

Due to the protective finish, there may be a light film on the surface of wood. To remove, wipe with a clean soft dry cloth. Do not use soap or a cleanser to remove the film. Overtime, direct sunlight will also remove the film.