

WORLD MARKET®

Assembly Instructions

Leona Farmhouse Side Chair

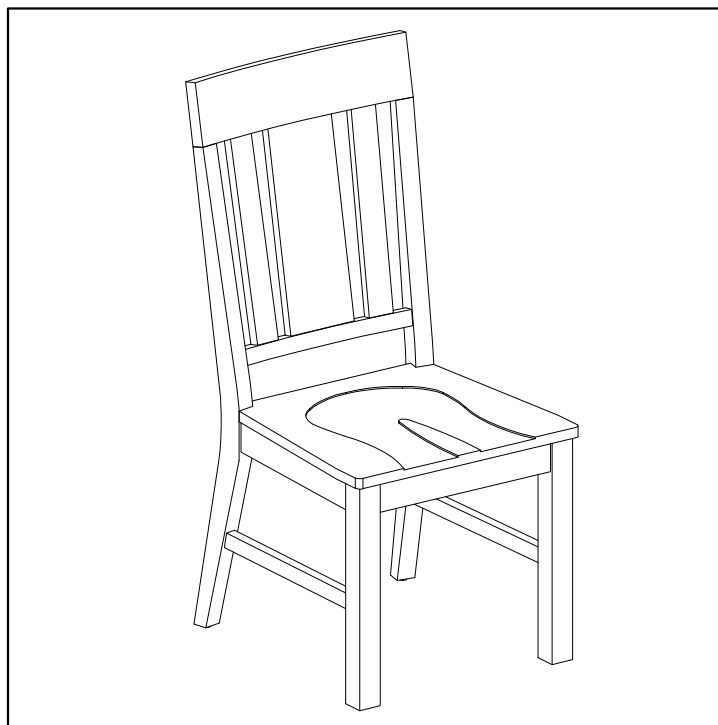

SKU - 542373, 596525





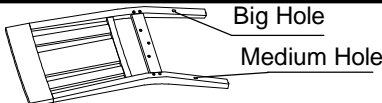
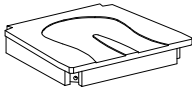

THANK YOU FOR YOUR PURCHASE. IF YOU HAVE ANY QUESTIONS PERTAINING TO THE ASSEMBLY OF THIS FURNITURE PIECE, PLEASE CONTACT THE NEAREST WORLD MARKET STORE. IF YOU ARE NOT NEAR A STORE, PLEASE CALL OUR CUSTOMER SERVICE CALL CENTER TOLL FREE AT 877- 967- 5362 FOR ASSISTANCE.

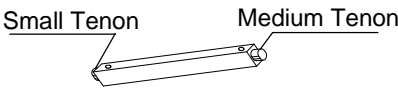
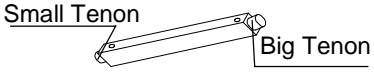
All products sold at World Market are not for commercial use and are intended for residential use only.

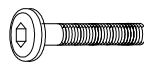
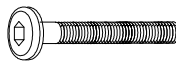

Component List

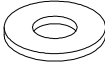
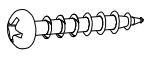
LABEL		DESCRIPTION	QTY
A		Back	1
B		Seat	1
C		Right Leg	1
D		Left Leg	1
E		Right Stretcher	1
F		Left Stretcher	1

Hardware List

LABEL		DESCRIPTION	QTY
H-1		Short Bolt M8x40mm	3
H-2		Long Bolt M8x90mm	4
H-3		Spring Washer M8x14mm	11
H-4		Flat Washer M8 x 20mm	11
H-5		Screw M4 x 50mm	4
H-6		Nut M8 x 7mm	4

Tool List

LABEL		DESCRIPTION	QTY
T-1		Allen Key M4 x 30 x 110mm	1
T-2		Open Wrench M13mm	1
T-3		Phillips head screwdriver (tool needed)	Not included

Assembly Preparation

Before Beginning:

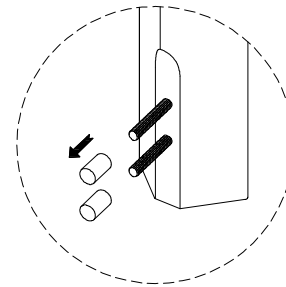
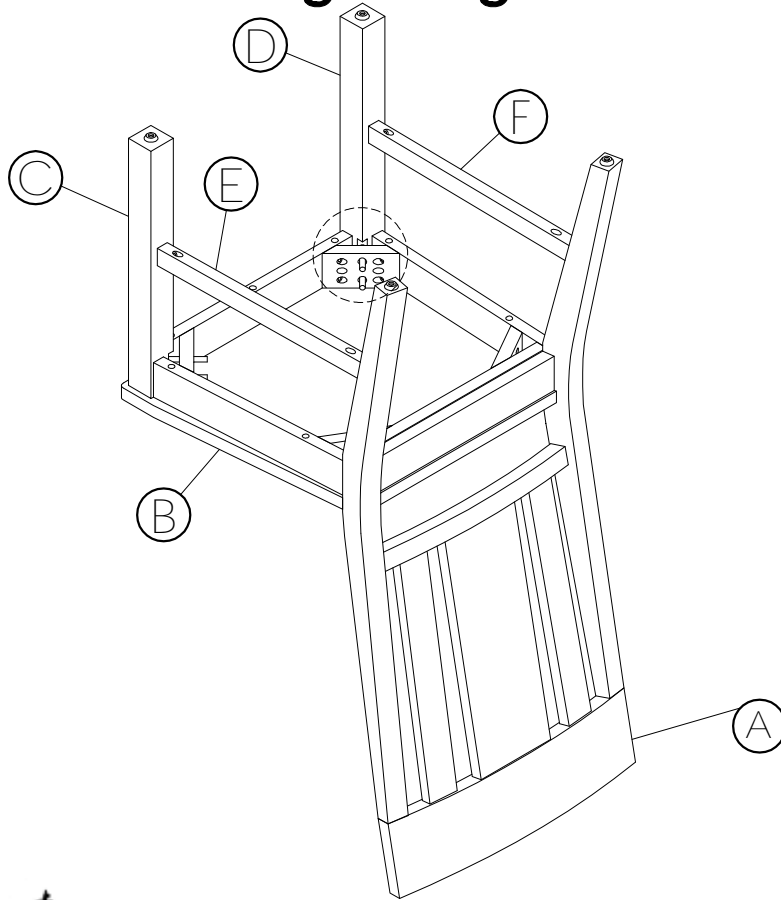

Remove plastic tube on bolts



- Unpack all hardware bags and components to ensure you have all parts.



- Read instructions, cover to cover.



- Have 2 adults on hand for assembly.



- Do not assemble on flooring or carpet.



- Assemble on a clean non-marring surface (packing foam).



- Save all packaging until finished.



- In case of missing parts, please contact your nearest World Market store or call our customer service call center at call 1-877-967-5362.



- **WARNING:** Small parts are a choking hazard. Adult Supervision is required before, during, and after assembly.

Assembly Steps

Step 1:

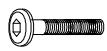

Short Bolt x 3



Long Bolt x 4



Spring Washer x 7



Flat Washer x 7

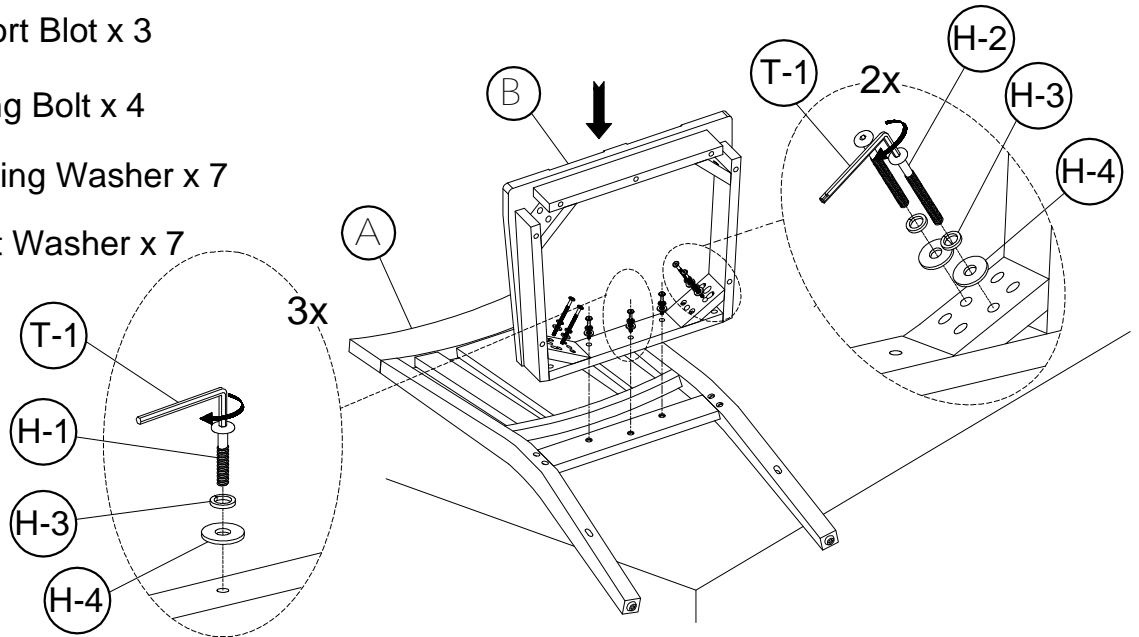

Position Back (A) onto a padded, no-marring surface such as a table top for ease of assembly. Position Seat (B) onto Back (A) as shown. Insert Long Bolts (H-2), Spring Washers (H-3) and Flat Washers (H-4) through holes in each corner of Seat (B) into receiving holes in Back (A), stacking the hardware in the order as shown. Insert Short Bolts (H-1), Spring Washers (H-3) and Flat Washers (H-4) through holes in back apron of Seat (B) into receiving holes in Back (A), stacking the hardware in the order as shown. Do not yet fully tighten Bolts.

Step 2:

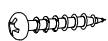

Screw x 2

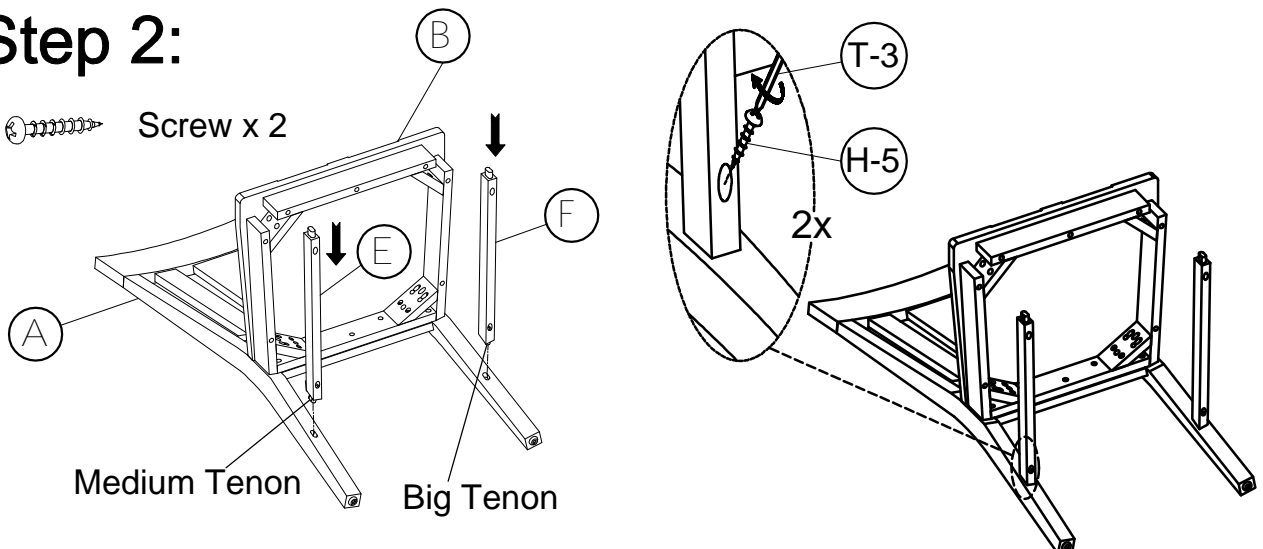

Position Right Stretcher (E) and Left Stretcher (F) to Back (A) as shown in illustration. Ensure screw holes are facing toward the bottom of the chair. Secure Screws (H-5) using a Phillips Head Screwdriver (T-3; not provided). Do not yet fully tighten Screws.

Assembly Steps

Step 3:

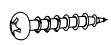

Screw x 2



Spring Washer x 4



Flat Washer x 4



Nut x 4

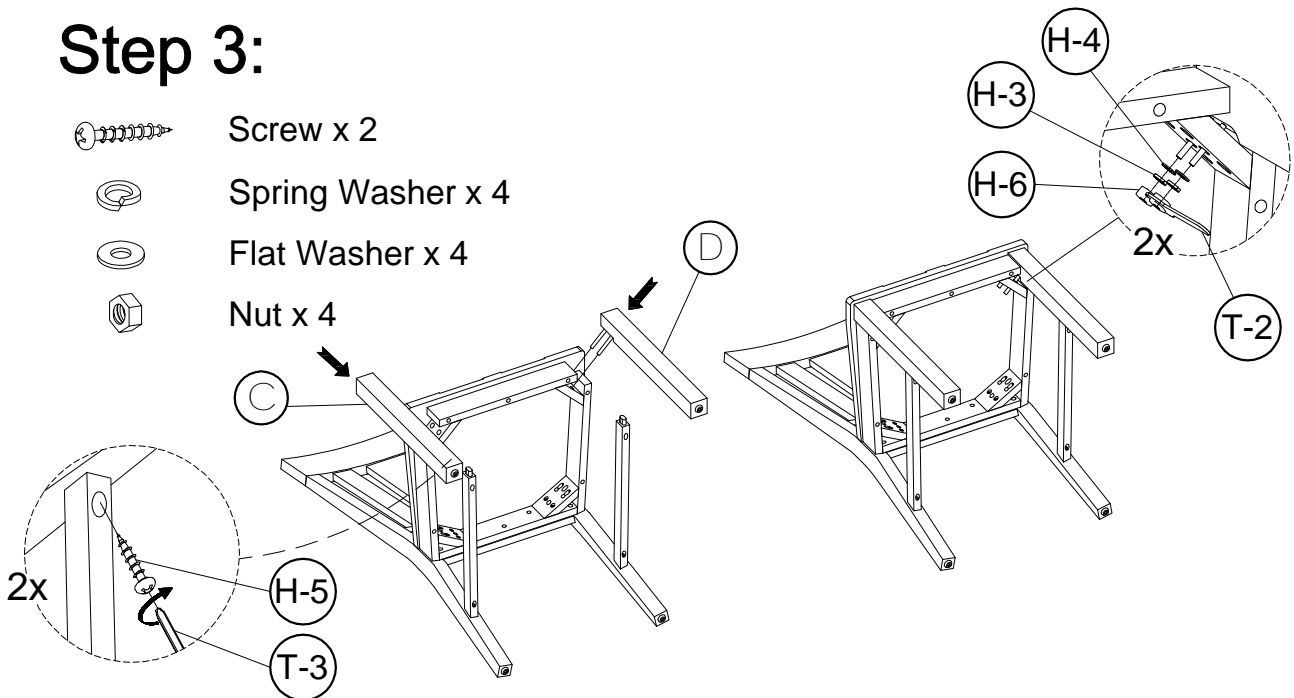

Position Legs (C/D) to Seat (B) and Right and Left Stretchers (E/F) as shown in illustration. Secure Legs (C/D) to Seat (B) with Nuts (H-6), Spring Washers (H-3), and Flat Washers (H-4) using provided Open Wrench (T-2), stacking the hardware in the order as shown. Secure Legs (C/D) to Right and Left Stretchers (E/F) with Screws (H-5) using a Phillips Head Screwdriver (T-3; not provided). Do not yet fully tighten Nuts and Screws.

Step 4:

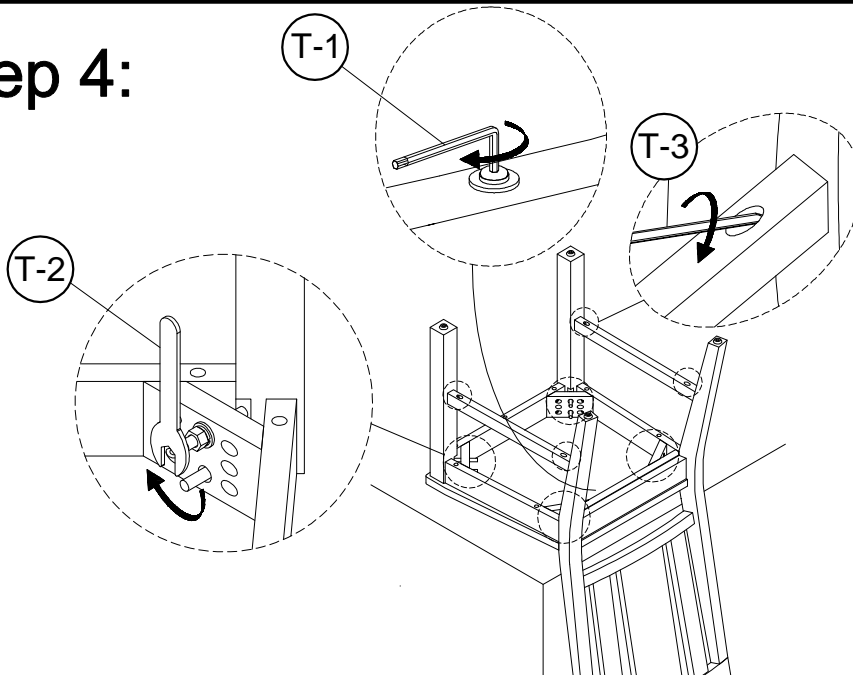

Turn assembly upside down as shown in illustration. Fully tighten all Bolts, Nuts and screws with Allen Key (T-1), Open Wrench (T-2) and Phillips Head Screwdriver (T-3; not included). Do not use power drill. Do not over tighten hardware.





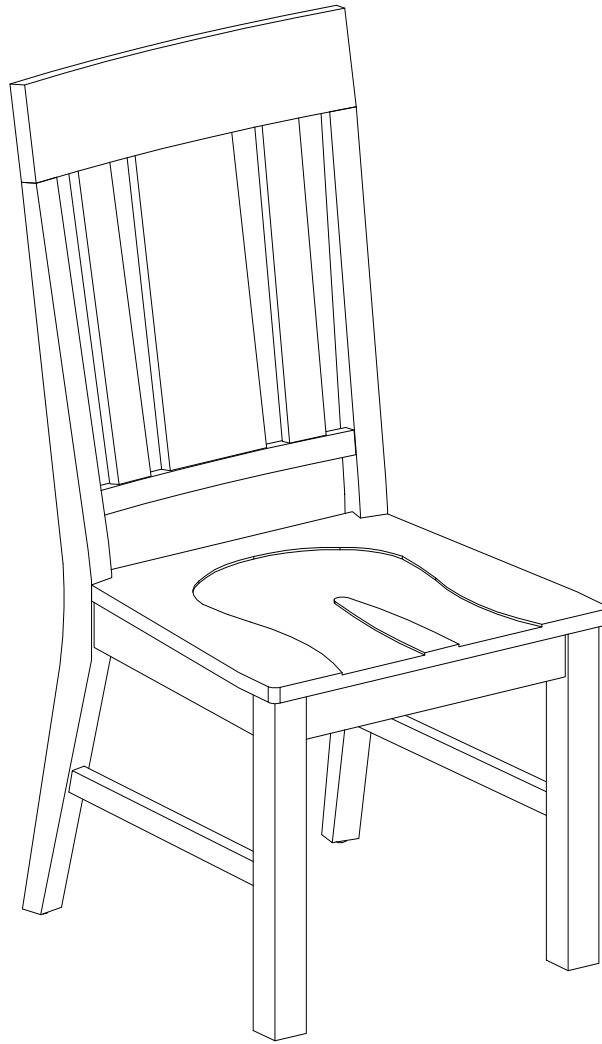

Assembly Steps

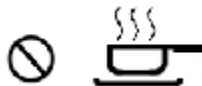

Step 5:



Place assembly onto legs. Assembly is now complete and ready for use.
Note: Check and tighten all nuts, bolts, and screws every 3 months.

Care & Maintenance

-  ● Do not put hot items directly on furniture surface.
-  ● Do not clean furniture with harsh cleansers or polish.
-  ● Do not place furniture in direct sunlight.
-  ● Do not place furniture near heating or cooling vents.
-  ● Do not write on furniture without a padded barrier to protect the surface.
-  ● Do not place furniture outside. For indoor use only.
-  ● All products sold at World Market are not for commercial use and are intended for residential use only.

-
-  ● Dust and pick-up spills using a clean, non-colored, lint-free, dry cloth.
 -  ● Stains may be removed with mild soap solution and damp cloth.

WORLD MARKET LIMITED ONE-YEAR WARRANTY – Indoor Furniture

For your customer satisfaction, this product carries a LIMITED ONE-YEAR WARRANTY from the date of purchase. This limited warranty only applies to World Market brand furniture, and not to other furniture brands sold on World Market's website.

Where applicable, the limited warranty provides coverage for:

1. **Manufacturing, Material and Workmanship Defects:** Includes defects related to core frame/structure substrates (wood and metal); cracking, splitting, or complete breakage of hardwood, plywood or medium density fiberboard (MDF); cracking, splitting or lifting of wood veneer or laminated top surfaces caused by process failure; broken welds or improperly coated metal frame components (powder coating or painted); fabric or leather material defects including tears, misprints, fraying, crease marks, skip stitches or open seams; support webbing material and sinuous spring defects or damage, including method of attachment to frame; and other component failures that are a direct result of manufacturing or workmanship defects.
2. **Cushions & Cushions with Enclosed Steel Pocket Coils:** Failed or ruptured steel pocket coils enclosed inside of seat cushions, or loss of resiliency from a material breakdown of foam or fiber filling, which should not be confused with softening or settling during normal use.
3. **Leather:** Splitting or cracking of leather material. NOTE: The warranty does NOT cover natural hide markings, variations in the leather color or grain due to the authentic natural properties of processed cowhide leather.
4. **Bonded Leather or Bi-cast Leather:** Separation of the polyurethane coating, peeling or cracking of the inner layer or at the bonded seam edges (bi-cast straps).
5. **Furniture Components (Hardware & Mechanisms):** Includes defects to pre-installed components or hardware provided to the customer for assembly such as office chair hydraulic lifts, lift mechanisms, metal bases and casters, swivel plate mechanisms; for drawers, metal glides, handles/knobs; for doors, hinges, magnetic latches; and other components such as bent or stripped threaded leg posts and adjustable levelers. For missing, damaged, corroded, or misplaced hardware components such as bolts or washers, please contact Customer Service at: 877-967-5362.

This LIMITED ONE-YEAR WARRANTY does NOT cover:

1. Damage due to mishandling during transportation from store or transportation without original protective packaging.
2. Abuse, negligence (product misuse) or wear and tear that may result in or from:
 - a. **Wood & Veneer:** Mishandling, exposure to moisture, peeling or discoloration caused by exposure to moisture or excessive sunlight, heat; splintered, dented or nicked panels, legs or component edges or paint/finish blemishes; or treatment with corrosive chemicals (dyes, inks, paints or harsh cleaning products).
 - b. **Fabric & Leather (Including Bonded or Bi-Cast Leathers):** cuts, punctures, tears, burns, pet damage, or treatment with corrosive chemicals (dyes, inks, paints or harsh cleaning products), exposure to direct sunlight, fire, high heat, water, or any bright light source (natural or artificial) that may cause splitting, peeling or flaking with time.
 - c. **Foam (Cushions):** Flattening, relaxing or settling/softening of foam components that comes with normal use.
 - d. **Hardware Components:** improper installation or misuse/substitution of hardware components not defined in the Assembly Instructions for the product (if applicable)
3. Damage due to environmental exposure to direct sunlight, fire, high heat, water or extreme humidity, any bright light source (natural or artificial), or any environment that the product is not intended for.
4. This warranty is applicable for indoor furniture products purchased for residential use only.

For additional information on returns, please visit: <https://www.worldmarket.com/category/customer-service/returns.do>

All products sold at World Market are NOT FOR COMMERCIAL USE and are intended for residential use only. Products purchased for commercial use will VOID all warranty provisions as listed above.

Any claims under this LIMITED ONE-YEAR WARRANTY are valid and applicable only as to the original purchaser and must be accompanied by proof of purchase. Warranty claims should be submitted to a World Market store or through World Market Customer Service Call Center, Toll Free at 877-967-5362.

For valid warranty claims, World Market will repair or replace the product, or offer a full or partial credit, in the sole discretion of World Market. This LIMITED ONE-YEAR WARRANTY gives you specific legal rights and you may also have other rights which vary from state to state.